

# INSTATRIKE

BY



Polaris Victory TC

# Limited Warranty

TOW-PAC, INC. warrants to the first end user purchaser that this product “InstaTrike” when purchased will be free from defective workmanship and materials, and agrees that it will, at its option, either repair the defect or replace the defective Product for the period of one year from date of original purchase.

This warranty does not apply to tires or to the appearance of any item which has been damaged, defaced, been subjected to misuse, or which has been altered or modified in design or construction.

Neither the sales personnel of the seller nor any other person is authorized to make any warranties other than those described above or to extend the duration of any warranties beyond the time period described above on behalf of TOW-PAC, INC.

## **NOTICE OF LIMITED LIABILITY**

Tow-Pac, Inc. warrants *only* components supplied by Tow-Pac, Inc. Tow-Pac, Inc. cannot be responsible for any components on owners motorcycle including frames, hardware, aftermarket accessories, etc. Owner is solely responsible for ensuring motorcycle is in sound mechanical order. Tow-Pac, Inc cannot be responsible for any damage due to improper installation of Tow-Pac components or use of any hardware (bolts, nuts, etc) on Tow-Pac components not supplied directly by Tow-Pac, Inc. Owner is solely responsible for installation of Tow-Pac components. Please refer to limited warranty for warranty details.

# Notice

***After your InstaTrike is installed, take some time to get used to “Trike” handling characteristics.***

- On a Trike you will ***steer*** rather than ***lean*** as you would on a conventional two wheel motorcycle.
- Take corners ***very slowly*** until you get used to the feel of cornering on a Trike.
- Remember to use your front brake in tandem with your rear brake. This will greatly increase your stopping power when in Trike configuration.
- With InstaTrike installed remember the outrigger wheels. Use caution not to run them into objects.
- Keep your feet up at all times.

# Important Notices

- *InstaTrike is designed for use on paved surfaces only. Use of InstaTrike on unpaved terrain may void warranty.*
- *Use care when installing screw jacks. Be certain that motorcycle is always in a stable balanced position.*
- *Periodically check bolts for tightness.*
- *InstaTrike is designed around a stock motorcycle. Some aftermarket accessories may be incompatible with the InstaTrike system*

# Receiver Hitch Installation

**NOTICE - Attach all bolts loosely until all bolts and brackets are in place. After all are in proper position tighten all bolts.**

**Important Notice** - It may be necessary to remove some aftermarket items (saddle bags, luggage racks, etc.) before installation of hitch brackets. After hitch is installed, aftermarket items can be reattached.

**Some aftermarket accessories may not be compatible with InstaTrike.**

- 1) Place motorcycle in an upright level position.
- 2) Remove exhaust pipe bolts (2 each side)
- 3) Attach bracket **A** (left) / **B** (right) to muffler mounts. Use new bolts provided.

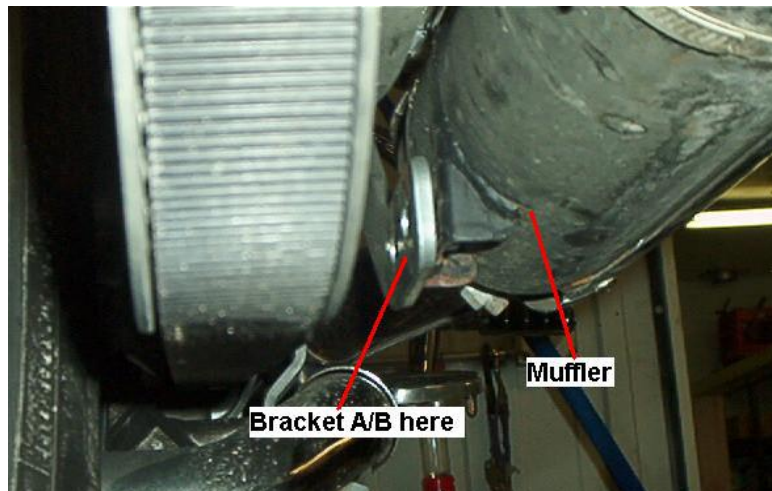

4) Remove rear sub frame

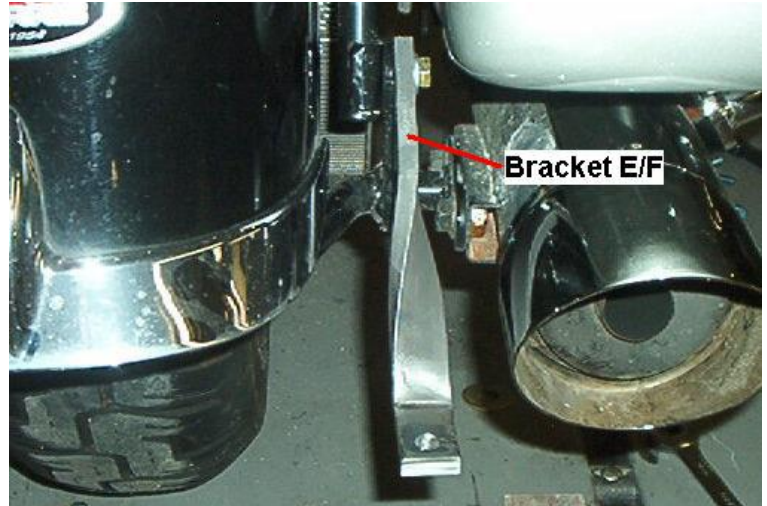
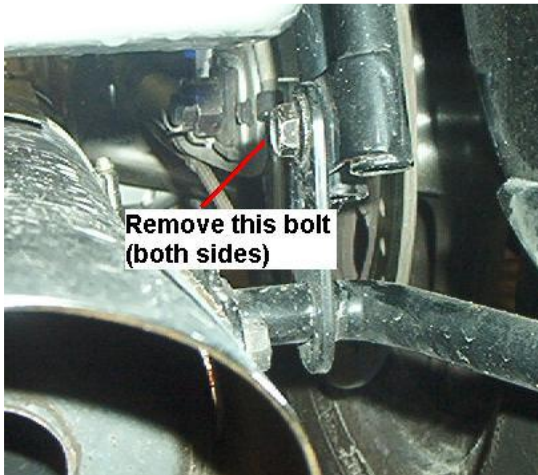

bolt and attach brackets **E** (left) / **F** (right) here using new bolt provided.

5) Attach front of bracket **C** (left) / **D** (right) to **BOTTOM** of **A/B**. Attach rear of **C/D** to **BOTTOM** of forward hitch arms.

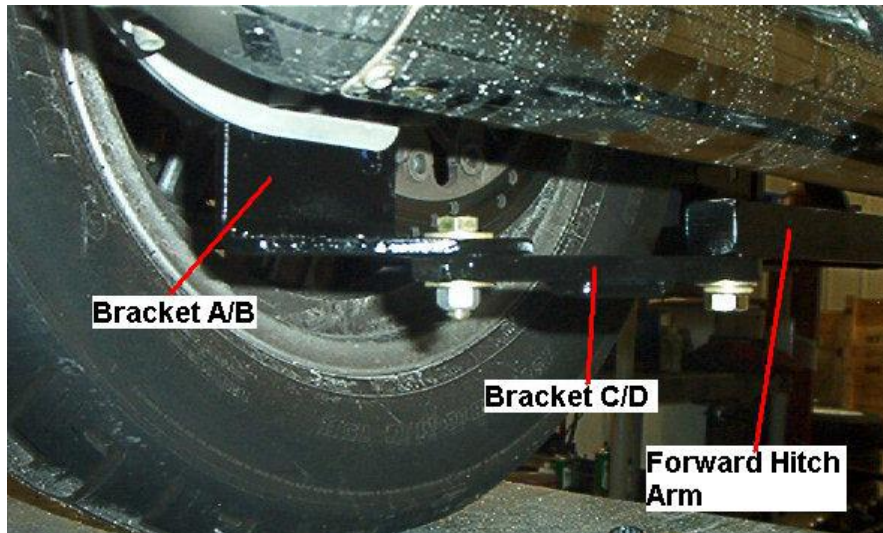

6) Attach rear of brackets **E** and **F** to **TOP** of rear hitch plate.

7) Tighten all bolts.

# Receiver hitch diagram

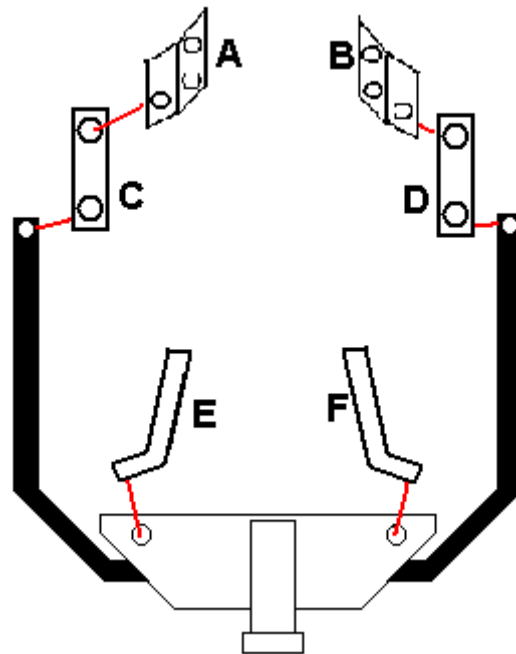

## Leveling stand screw jack installation

*After hitch is installed, install leveling stand screw jacks to hold motorcycle in an upright and level position in order to install or remove InstaTrike.*

- 1) Thread right side screw jack into leveling stand bracket on bracket **D** and adjust leveling jack bolt out until motorcycle will be level against it.
- 2) Push motorcycle over from left side until right screw jack is touching floor.
- 3) Install left side screw jack onto bracket **C** and adjust out until motorcycle will rest upright on both screw jacks.
- 4) Adjust screw jacks until motorcycle is level.

***CAUTION - Use screw jacks to hold motorcycle upright and level ONLY. Do not lift motorcycle with screw jacks.***

***CAUTION - Use care when installing screw jacks. Be certain that motorcycle is always in a stable balanced position.***

# InstaTrike Installation

1. Place your motorcycle on a smooth level surface and attach leveling jack stands.
2. Push the hitch mount into the receiver hitch. (this might be a little difficult until you get use to doing it. Removing the paint from the hitch mount and applying a little grease will help.)
3. Place the hitch pin through the receiver hitch and hitch mount (*alignment plate*). Install and tighten the tension bolt.
4. Align InstaTrike wheels. (*initial installation only. Check periodically and realign if necessary*)
5. Bolt leanstop braces to hitch. (Bolt inserts from the bottom) Be certain to replace washers/spacers in the same configuration as when you removed them.
6. Remove leveling jack stands.
7. Check all bolts for tightness.
8. You are now ready for the test ride.
  - A. Keep your feet up!
  - B. Ride slowly in first gear until you are comfortable with the Tow-Pac system.

# Leanstop Braces

- When installing InstaTrike, bolt leanstop brace to receiver hitch by inserting bolt from *TOP* through the leanstop brace and washers/spacers. Thread bolt into bracket on hitch and tighten.
- When removing InstaTrike reverse the above procedure.
- Adding or removing washers/spacers between receiver hitch and leanstop brace will allow you to level your motorcycle if necessary.
- Removing washers/spacers between receiver hitch and leanstop brace will allow for more traction on motorcycle rear wheel.

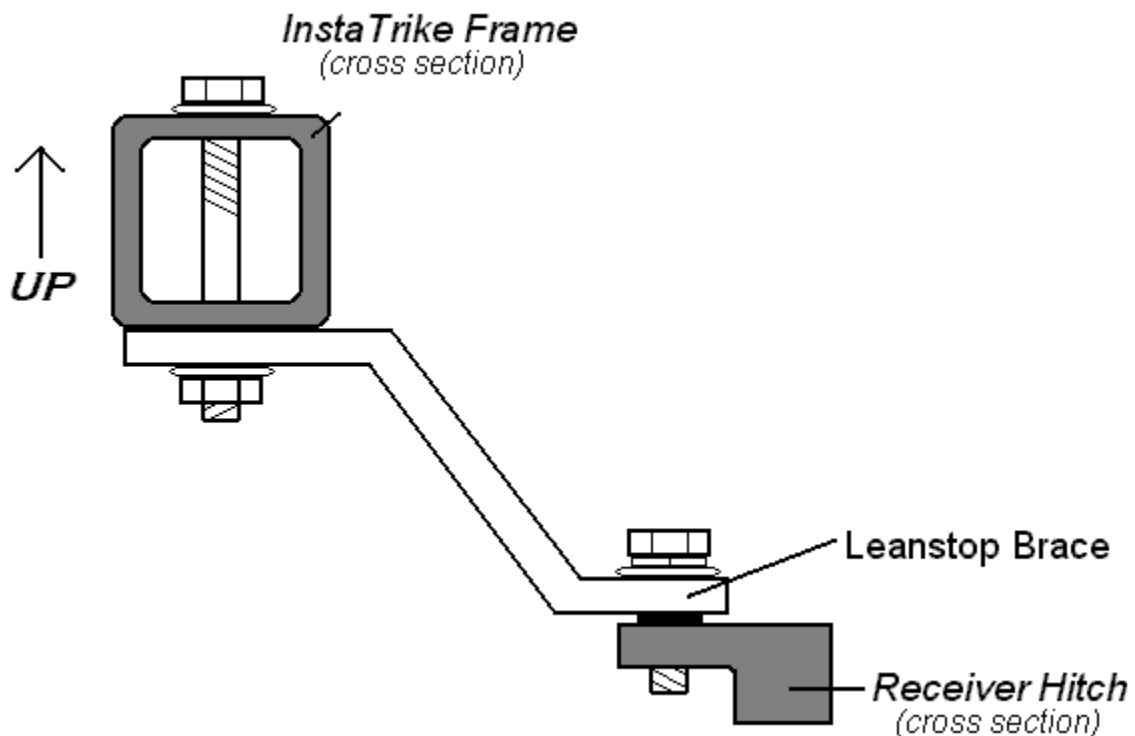

## **Wheel Height / Traction Adjuster**

The wheel height/traction adjuster (right and left side) allows you to selectively adjust the position of your trike wheels in order to customize ride, handling, level, and traction characteristics. Your trike is shipped with the adjuster preset to an optimum position for your model of motorcycle however you can make whatever adjustments necessary to customize to your bike and personal preference.

**Shortening** the adjuster arm **raises** the trike wheels and places more of the weight of your motorcycle on the motorcycle wheel. This increases motorcycle traction and gives a generally softer ride.

- 1) Loosen jam nuts
- 2) Shorten adjuster arm by turning adjuster nut **A** toward bolt **C** desired amount.
- 3) Turn adjuster nut **B** until it tightens against adjuster bracket and adjuster nut **A**
- 4) Tighten nuts **A** and **B** and jam nuts

**Lengthening** the adjuster arm **lowers** the trike wheels and places more of the weight of your motorcycle on the trike wheels. This gives a firmer ride and increases handling/cornering.

- 1) Loosen jam nuts
- 2) Lengthen adjuster arm by turning adjuster nut **B** toward bolt **D** desired amount.
- 3) Turn adjuster nut **A** until it tightens against adjuster bracket and adjuster nut **B**
- 4) Tighten nuts **A** and **B** and jam nuts

If necessary the pivot bolt and bolts C and D and be loosened for adjustment  
***Be certain to retighten all bolts after adjustment.***

***NOTICE: Check all bolts and nuts periodically for tightness***

***NOTICE: Be sure motorcycle is level after adjustment.***

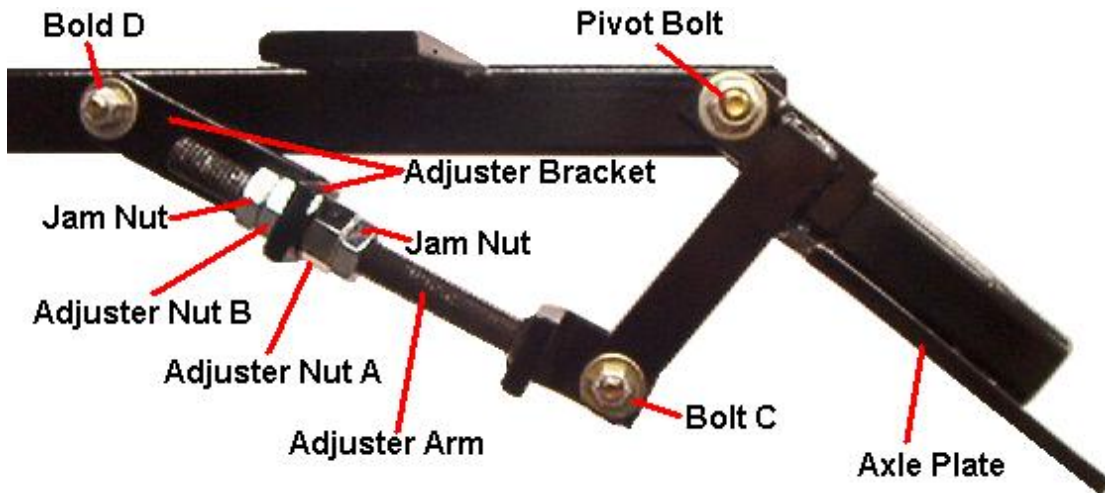

# Wheel Alignment

*Wheel alignment is critical for proper tire wear and handling.*

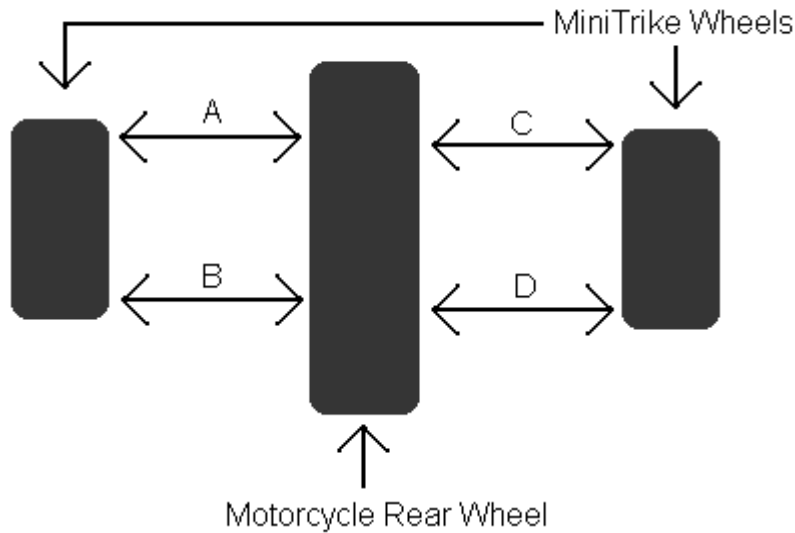

***Top View***

With InstaTrike installed and motorcycle on center stand, measure **A** and **B**. Loosen axle plates and align wheel so **A** and **B** are equal to within 1/16<sup>th</sup> of an inch. Tighten axle

bolts and torque to 45 pounds. Repeat for **C** and **D**.

**NOTE:** The measurement of *A* and *B* may not be the same as *C* and *D*. This is normal and presents no difficulty.

## InstaTrike Assembly Diagram

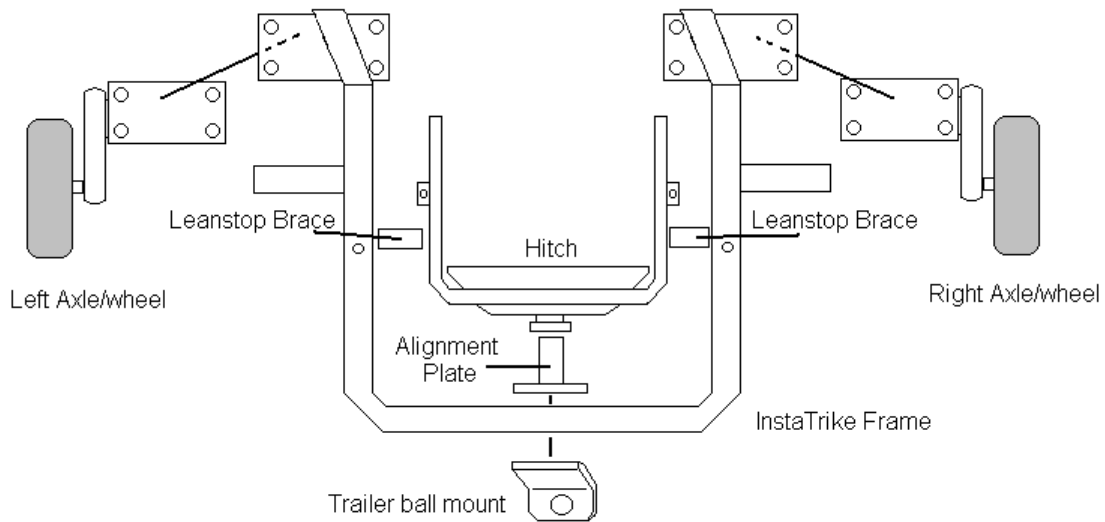

**Top View**

## Fender Installation Instructions *(12 Inch wheel only)*

- 1) Attach fender brackets to trike frame with spacers **BETWEEN** fender bracket and frame. Tighten.  
**NOTE: Leave fender bolts loose until all bolts are inserted.**
- 2) Place gray plastic washers between fender and trike frame/fender bracket. (4 washers each side)
- 3) Place fender on frame. Carefully align mounting holes.
- 4) Insert long bolts first. (2 each side)
- 5) Insert short bolts second. (3 each side) **Insert top bolt first.**
- 6) Carefully tighten bolts. Use care not to over tighten.

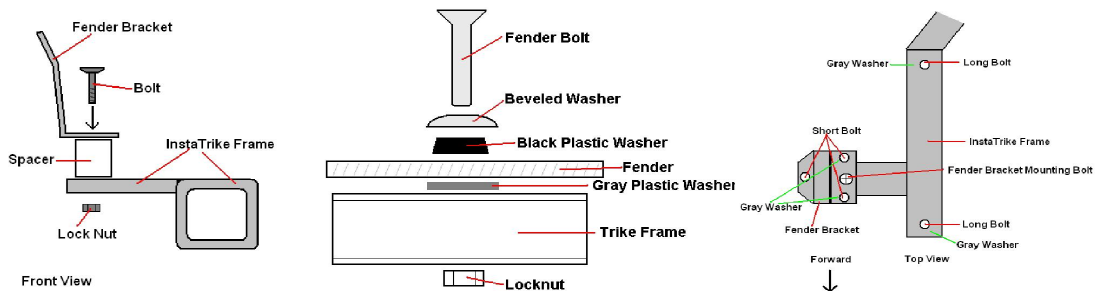

## Reflector Mounting Instructions

- 1) Be sure fender is clean and free from dust  
*Do not apply reflectors in direct sunlight or on a hot surface*
- 2) Remove backing from reflector and carefully position on fender.  
*See Diagram Below*

**Lightly spraying back of reflectors with a mild solution of water or Windex will allow easier positioning. Allow reflectors at least one hour to dry before riding if using this method.**

